

## CONTENTS

- Receiving Procedures
- Warranty
- Safety Information
- Machine Description
- Operating Instructions
- Maintenance

### Receiving Procedures

Every Morse drum handler is inspected prior to shipping. However, damage may be incurred during transit.

- Check for visible damage. If you choose to accept damaged freight, always sign noting the damage on the **BILL OF LADING**.
- Document the damage and have the truck driver sign. We recommend keeping a digital camera at your receiving dock for this purpose.
- Open packages expeditiously to check the condition of the goods. There is only a 24 hour window to notify the carrier of any concealed damage.
- **IMMEDIATELY REPORT ALL DAMAGE TO THE SHIPPING COMPANY!** Then you may contact Morse for assistance with your freight claim.
- Morse Manufacturing will not be held responsible for any damaged freight that is not signed for as damaged.

### Limited 2 Year Warranty

Morse drum handling equipment is guaranteed against defects in workmanship or materials for **TWO YEARS** when used properly within its rated capacity. Warranty does not cover wear from normal use or damage from accident or abuse. Motors and other purchased parts carry the warranties of their manufacturers.

For warranty claims, contact your Morse Dealer to obtain a return authorization number, and for return freight advice. Return freight must be prepaid.

In all instances, liability is limited to the purchase price paid or to repairing or replacing the product. Customer assumes liability for any modifications, unauthorized repairs or parts substitution.

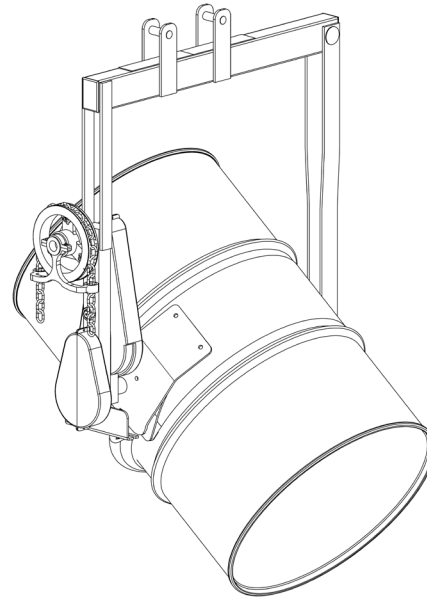

### Safety Information

While Morse Manufacturing Co. drum handling equipment is engineered for safety and efficiency, a high degree of responsibility must be placed upon the machine operator to follow safe practices, based primarily on common sense, upon which true safety depends.

Failure to follow the safety precautions in this manual can result in personal injury or property damage. Observe the same precautions as with similar machinery where carelessness in operating or maintenance is hazardous to personnel. Carefully read the safety precautions below and throughout this manual.

Review the Material Safety Data Sheet(s) for the material(s) in the drum(s) and take all necessary precautions. Safety shoes, work gloves, hard hat and other personal protective devices are recommended.

Prior to initial use, inspect all moving parts and test rotation of chain wheel and drum holder assembly. Inspect drum holder assembly for proper operation. Perform necessary load test, inspections, operator training, etc.















**DANGER** - Indicates a situation which, if not avoided, will result in serious injury or death. This signal word is limited to the most extreme situations.



**WARNING** - Indicates a situation which, if not avoided, could result in serious injury or death.



**CAUTION** - Indicates a situation which, if not avoided, can result in damage to the machine.

	<b>WARNING</b> - Kontrol-Karriers are designed to handle one drum of the types listed in Machine Description. DO NOT attempt to handle any other type of drum or object.
	<b>WARNING</b> - DO NOT exceed the weight capacity of 1500 Lb. (680 kg).
	<b>WARNING</b> - DO NOT operate damaged or malfunctioning unit, or a unit with missing parts.
	<b>WARNING</b> - DO NOT lift people or suspend loads over people. Stay clear of suspended loads.
	<b>WARNING</b> - DO NOT lift loads higher than necessary.
	<b>WARNING</b> - DO NOT leave suspended loads unattended.
	<b>WARNING</b> - DO NOT remove or obscure warning labels.
	<b>WARNING</b> - DO NOT operate without first having read and understood operating manual.
	<b>WARNING</b> - Do Not Modify the Unit. Under no circumstances should any modifications be made to the Morse machinery without factory authorization. Any modifications may void the warranty. This machine was designed to perform a specific job and alterations may result in injury to operator or machine.
	<b>WARNING</b> - No Loose Fitting Clothing. Wear close-fitting clothing and safety equipment appropriate to the job. Loose fitting clothing may become caught on the machinery and cause severe personal injury.
	<b>CAUTION</b> - Wear safety shoes with non-slip soles and hard toe protection.
	<b>CAUTION</b> - DO NOT allow drum to impact on floor, ground, or dumping station, etc.
	<b>WARNING</b> - This product can expose you to chemicals including barium sulfate, cobalt, titanium dioxide, and 2-methylimidazole, which are known to the State of California to cause cancer, and bisphenol-A, which is known to the State of California to cause birth defects or other reproductive harm. For more information go to <a href="http://www.P65Warnings.ca.gov">www.P65Warnings.ca.gov</a>

### Machine Description

**Model 185AM-HD** Heavy-Duty Kontrol-Karrier is designed to lift, transport, and dispense a ribbed 55-gallon (210 liter) steel or fiber drum 22" to 23.5" (56 to 59.7 cm) in diameter. The maximum full-drum capacity is 1500 Lb. (680 kg). The capacity is derated to 800 Lb. (363 kg) for a half-full drum. The half-full rating is based on the tilt mechanism's capacity for handling an unbalanced bottom-heavy drum.

**MORSE**  
Mfg. Co., Inc.  
E. Syracuse, NY

**1500 Lb.**  
**( 680 kg )**

**Max. Capacity**

The Specialist in Drum Handling Equipment

Made in U.S.A.

### Important

1. Please read all instructions thoroughly before attempting to operate your new Morse drum handler.
2. When loading, unloading, operating, or maintaining your MORSE drum handler, always use care and good judgment. Maintain secure footing and a firm hold. Keep hands and loose clothing away from all moving parts. Never allow anyone to be below any part of a raised drum handler or drum. Read operating instructions and review the pictures in the sales brochure before operation.
3. The 185 Series are a "Group 1 structural and mechanical" below-the-hook lifting device which are covered by the American National Standard ASME B30.20. The user should comply with all aspects of this standard.

### Operating Instructions

1. Start with Heavy-Duty Kontrol-Karrier on the floor. Lower hoist and engage hoist hook to lift Heavy-Duty Kontrol-Karrier.
2. Raise hoist to lift Heavy-Duty Kontrol-Karrier clear of floor and transport it to the drum.
3. Suspend Heavy-Duty Kontrol-Karrier at a height which aligns drum saddle with center of drum.
4. With cinch chain hanging freely, swing the ratchet hinge plate to open position, push Heavy-Duty Kontrol-Karrier against drum so that saddle will encircle drum.
5. Secure the drum: drape the cinch chain across the face of the drum and engage a link into the slot in the ratchet (shown right). Turn the ratchet clockwise to tighten chain. If the chain doesn't cinch tightly on the drum, lift the pawl to loosen and release the chain and try again with a different link in the notch. Firm hand pressure on the ratchet handle should tighten the chain sufficiently to hold the drum. **DO NOT** use mechanical aids such as a pipe to extend handle for extra leverage.



6. Raise hoist and position drum at pouring station.
7. Pour the drum by pulling on the pull chain and rotating the drum to a suitable pouring angle. For best control of drum pouring angle, pay out one side of the chain loop while pulling in the other side, thus being able to hold back the drum rotation. The chain lock on the bottom of the power arm can be used to prevent drum rotation. To do so, crisscross the chain and insert in each slot of the chain lock.

If the drum handler is equipped with the MORStop Tilt-Brake, there is no need to hold tension on both sides of the chain loop. Braking is immediate and self actuating, without additional steps by the operator.

To add the MORStop Tilt-Brake to your drum handler, order Kit 3900-P for field installation.

8. After pouring is completed, rotate drum back to vertical position and lower hoist to return drum to floor.
9. To remove drum: Pull ratchet handle clockwise to relieve pressure on ratchet teeth. Lift pawl handle (item 103) to release teeth engagement and rotate ratchet to loosen chain and allow its removal from notch.

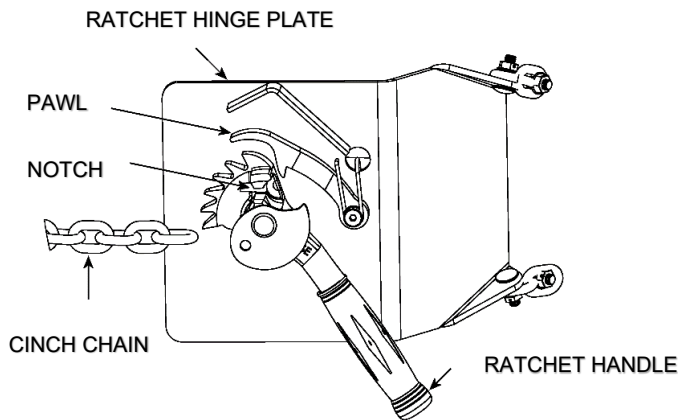

### Maintenance

Periodic inspection for the general condition of structural and mechanical components is imperative for safe and efficient operation.

1. Lubricate gear teeth and roller chain.
2. Clean and oil ratchet, pawl and other moving parts periodically. Clean and lubricate more often in environments where dust, dirt or other foreign particles will effect the performance of moving parts.
3. Periodically inspect all moving parts, framework, drum holder and contact areas for signs of wear, fatigue, or loosening. Tighten, adjust, or replace parts as necessary to prevent failure and maintain proper function.
4. Worn or damaged parts must be properly replaced with the correct, genuine Morse parts.